

UTILIZZO

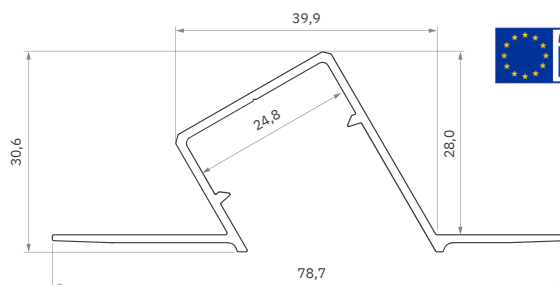

Profilo incassato, adatto alla finitura con intonaco, progettato per illuminazione d'accento e installazione di 2 strisce LED. Idoneo per l'uso su soffitti o pareti.





Metodi di assemblaggio

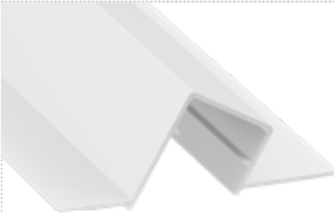

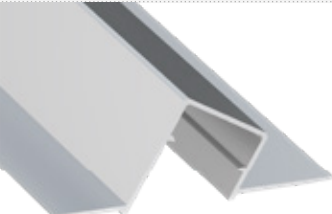
Profili per LED

	Bianco (verniciato RAL9016)	Nero (verniciato RAL9005 opaco)	Argento (anodizzato)
Colori del profilo			
1,0 m	10-1151-10	10-1155-10	10-1154-10
2,0 m	10-1151-20	10-1155-20	10-1154-20
3,0 m	10-1151-30	10-1155-30	10-1154-30
Larghezza della striscia led (mm)	fino a 22,8		

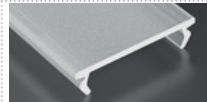
Covers "Duo" (montato dall'alto, snap-on)

	Milky (PMMA)	Frosted milky (PMMA)	Nero (PMMA)
Colori della cover			
1,0 m	10-0011-10	10-0012-10	10-0013-10
2,0 m	10-0011-20	10-0012-20	10-0013-20
3,0 m	10-0011-30	10-0012-30	10-0013-30
	☼ PMMA 50%	☼ PMMA 85%	☼ PMMA 22,67%

Tappi finali (plastica)

CON FORO					
BIANCO		NERO		ARGENTO	
SINISTRA	DESTRA	SINISTRA	DESTRA	SINISTRA	DESTRA
					
ABS 12-1341-00	ABS 12-1351-00	ABS 12-1342-00	ABS 12-1352-00	*ABS lacq. 12-1345-00 / **ABS 12-1344-00	*ABS lacq. 12-1355-00 / **ABS 12-1354-00

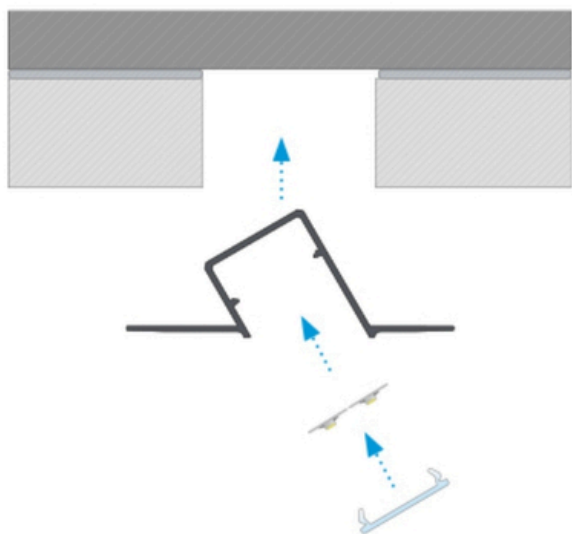

Manuale di installazione profilo "Twin" con copertura "Duo", fresata montata tra le due lastre di cartongesso

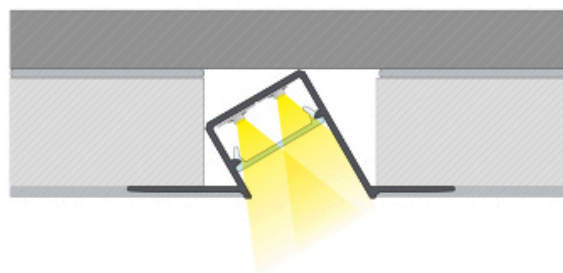

Risultato finale dell'assemblaggio del profilo "Twin" con copertura "Duo", cava montata tra due lastre di cartongesso con finitura intonacata

Schema di montaggio

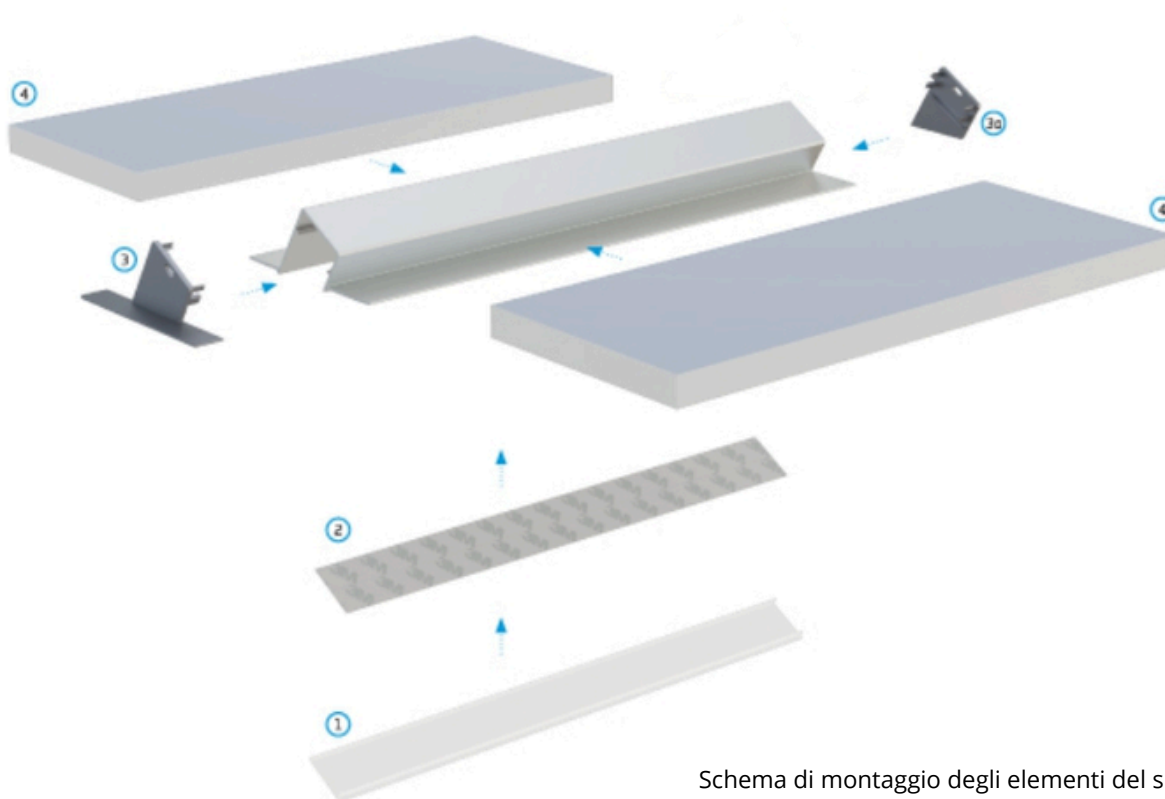

Schema di montaggio degli elementi del sistema di illuminazione utilizzando il profilo da incasso "Twin" copertura "Duo", strip LED, tappi

Metodi di installazione di una cover (Duo)

1. Installazione facendo click

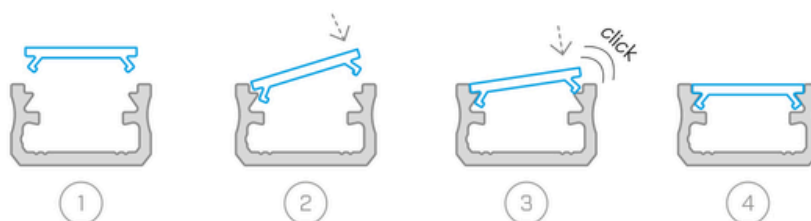

2. Installazione mediante scorrimento nel profilo

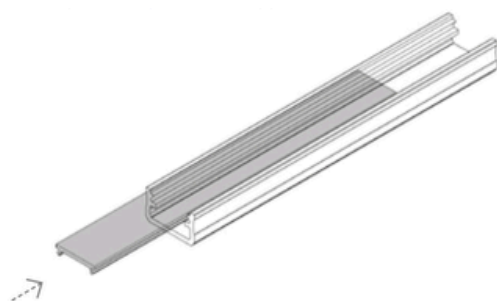

3. Non dovrete avere difficoltà ad inserire la cover, prova a fare clic sulla prima parte e fai scorrere la parte rimanente

